

SPECIFICATIONS

GNSS Features

Channels.....	336, 1598 (optional)
GPS.....	L1C/A, L1C, L2C, L2E, L5
GLONASS.....	L1C/A, L1P, L2C/A, L2P, L3
BDS.....	B1, B2, B3
GALILEO.....	E1, E5A, E5B, E5AltBOC, E6
SBAS.....	L1C/A, L5 (Just for the satellites supporting L5)
IRNSS.....	L5
QZSS.....	L1C/A, L1 SAIF, L2C, L5, LEX
MSS L-Band.....	Trimble RTX ^[1]
Positioning output rate.....	1Hz~50Hz
Initialization time.....	< 10s
Initialization reliability.....	>99.99%

Positioning Precision

Code differential GNSS positioning.....	Horizontal: 0.25 m + 1 ppm RMS Vertical: 0.50 m + 1 ppm RMS
GNSS static.....	Horizontal: 2.5 mm + 0.5 ppm RMS Vertical: 5 mm + 0.5 ppm RMS
Real-time kinematic..... (Baseline<30km)	Horizontal: 8 mm + 1 ppm RMS Vertical: 15 mm + 1 ppm RMS
SLink (RTX) ^[2]	Horizontal: 4-10 cm Vertical: 8-20 cm
RTK XTRa (xFill) ^[3]	Horizontal: 5 + 10 mm/min RMS Vertical: 5 + 20 mm/min RMS
SBAS positioning.....	Typically<5m 3DRMS
RTK initialization time.....	2~8s
IMU tilt angle.....	0°~60°

Hardware Performance

Dimension.....	15.3cm(φ)×10.6cm(H)
Weight.....	1.2kg (battery included)
Material.....	Magnesium aluminum alloy shell
Operating temperature.....	-25°C~+65°C
Storage temperature.....	-35°C~+80°C
Humidity.....	100% Non-condensing
Waterproof/Dustproof.....	IP68 standard, protected from long time immersion to depth of 1m IP68 standard, fully protected against blowing dust
Shock/Vibration.....	Withstand 2 meters pole drop onto the cement ground naturally
Power consumption.....	2W
Power supply.....	6-28V DC, overvoltage protection
Battery.....	7.4 V 3400mAh rechargeable, removable Lithium-ion battery
Battery life.....	16h (static mode) 10h (internal UHF base mode) 12h (rover mode)

Communications

I/O Port.....	5PIN LEMO external power port + Rs232 7PIN LEMO +external USB(OTG)+Ethernet 1 UHF antenna interface 1 GPRS antenna interface (internal and external antenna switchable) SIM card slot (standard)
Internal UHF.....	Radio receive and transmit, 1W/2W/3W switchable, radio router and radio repeater
Frequency range.....	410-470MHz
Communication protocol.....	Farlink, Trintalk450s, SOUTH, SOUTH+, SOUTHx, HUACE, Hi-target, Satel
Communication range.....	Typically 15km with Farlink protocol
Cellular mobile network.....	Advanced 5G network communication module, downward compatible with 4G/3G
Bluetooth.....	Bluetooth 4.0 standard, Bluetooth 2.1+EDR
NFC Communication.....	Realizing close range (shorter than 10cm) automatic pair between receiver and controller(controller requires NFC wireless communication module else)

WIFI

Modem.....	802.11 b/g standard
WIFI hotspot.....	Receiver broadcasts its hotspot form web UI accessing with any mobile terminals
WIFI datalink.....	Receiver can transmit and receive correction data stream via WiFi datalink

Data Storage/Transmission

Storage.....	64GB SSD internal storage Automatic cycle storage (The earliest data files will be removed automatically while the memory is not enough) Support external USB storage The customizable sample interval is up to 50Hz
Data transmission.....	Plug and play mode of USB data transmission Supports FTP/HTTP data download
Data format.....	Differential data format: CMR+, SCMRx, RTCM 2.1, RTCM 2.3, RTCM 3.0, RTCM 3.1, RTCM 3.2 GPS output data format: NMEA 0183, PJK plane coordinate, Binary code, Trimble GSOF Network model support: VRS, FKP, MAC, fully support NTRIP protocol

Sensors

Electronic bubble.....	Controller software can display electronic bubble, checking leveling status of the carbon pole in real-time
IMU.....	Built-in IMU module, calibration-free and immune to magnetic interference
Thermometer.....	Built-in thermometer sensor, adopting intelligent temperature control technology, monitoring and adjusting the receiver temperature

User Interaction

Operating system.....	Linux
Buttons.....	2-button and visual operation interface
Indicators.....	2 LED indicators, data interaction indicator and Bluetooth indicator
LCD.....	1.54-inch HD color LCD touch screen with resolution 240*240
Web interaction.....	With the access of the internal web interface management via WiFi or USB connection, users are able to monitor the receiver status and change the configurations freely
Voice guidance.....	The intelligent voice technology provides status and operation voice guidance, supports Chinese/English/Korean/Spanish/Portuguese/Russian/Turkish
Secondary development.....	Provides secondary development package, and opens the OpenSIC observation data format and interaction interface definition
Cloud service.....	The powerful cloud platform provides online services like remote manage, firmware update, online register and etc

[1] It requires a subscription to data service.

[2] The RTX accuracies depend on correction service chosen. And 95% of the time with initializations are around 5-30 minutes.

[3] RTK XTRa also requires a subscription to the data service, and precision is dependent on GNSS satellite availability. RTK XTRa positioning ends after 5 minutes of radio downtime.

Remarks: Measurement accuracy and operation range might vary due to atmospheric conditions, signal multipath, obstructions, observation time, temperature, signal geometry and number of tracked satellites. Specifications subject to change without prior notice



SOUTH
Target your success

METOP, Lda
Material de Escritorio, Equip.
Topográfico & Consultoria

INNO7

- Smart interactive RTK receiver -

5G, brings you an outstanding future



5G



TOUCH OLED



15KM UHF



IMU



64G
SSD STORAGE

SOUTH
Target your success

SOUTH SURVEYING & MAPPING TECHNOLOGY CO., LTD.

Add: South Geo-information Industrial Park, No.39 Si Cheng Rd, Guangzhou, China
Tel: +86-20-23380888 Fax: +86-20-23380800
E-mail: mail@southsurvey.com export@southsurvey.com impexp@southsurvey.com gnss@southsurvey.com
http://www.southinstrument.com http://www.southsurvey.com

5G Network >>>

A highway to the era of big data

INNO7 is equipped with a high-speed 5G full netcom module, which supports the latest 5G communication network and gives the RTKs high speed information interaction and wider expansion space in the big data era. Based on intelligent PPP dial up technology, INNO7 realizes automatic dialing in real-time and keeps online during working.

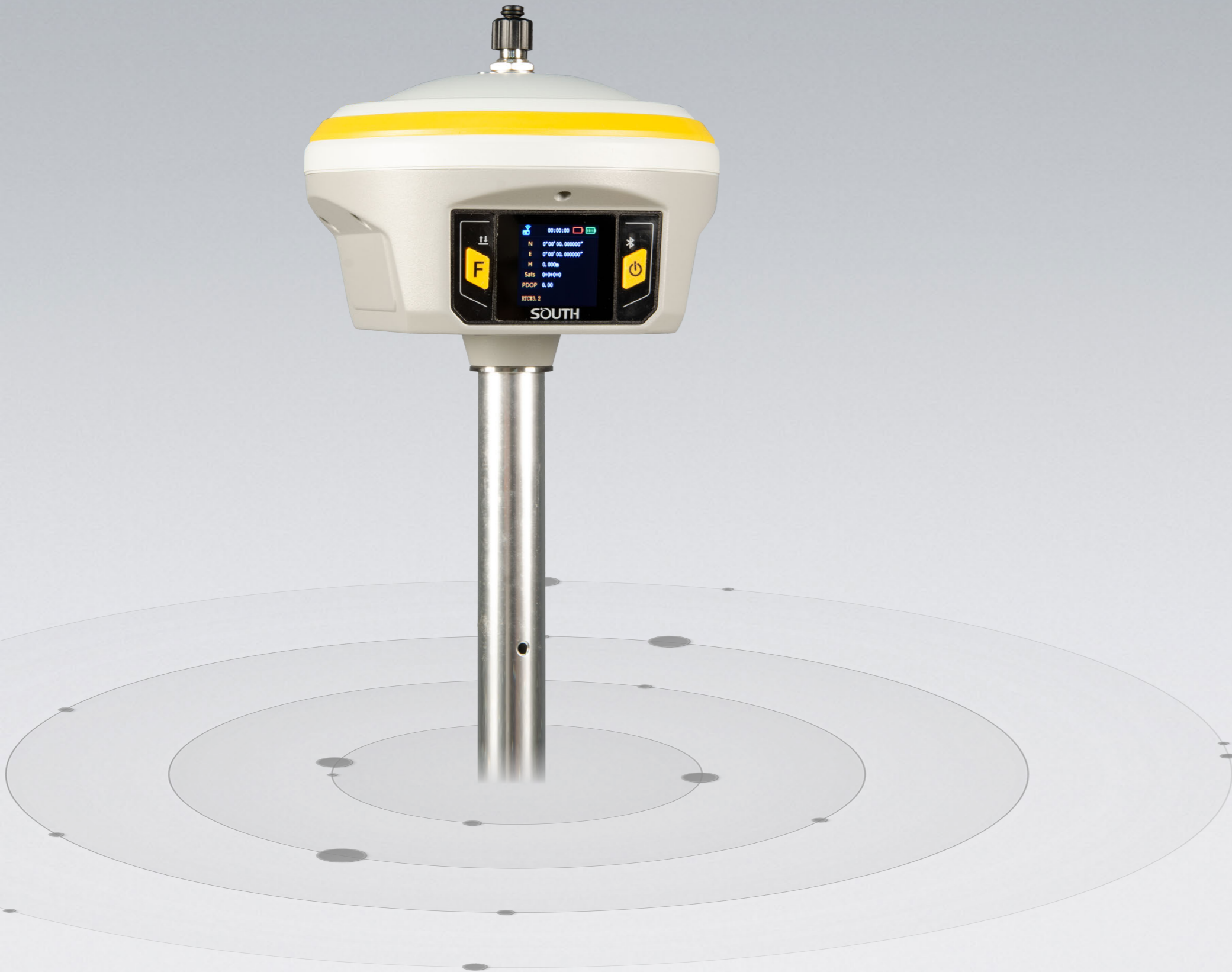

FarLink Protocol >>>

INNO7 adopts an internal radio with 3W maximum transmission power to achieve the typical working range as 15km through “**Far-link**” protocol.

The transmission bandwidth becomes large, which perfectly solves the problem of large data volume of multiple constellations transmission. And the power consumption can reduce about 60% in the same amount of data transmission compare to the traditional RTK.

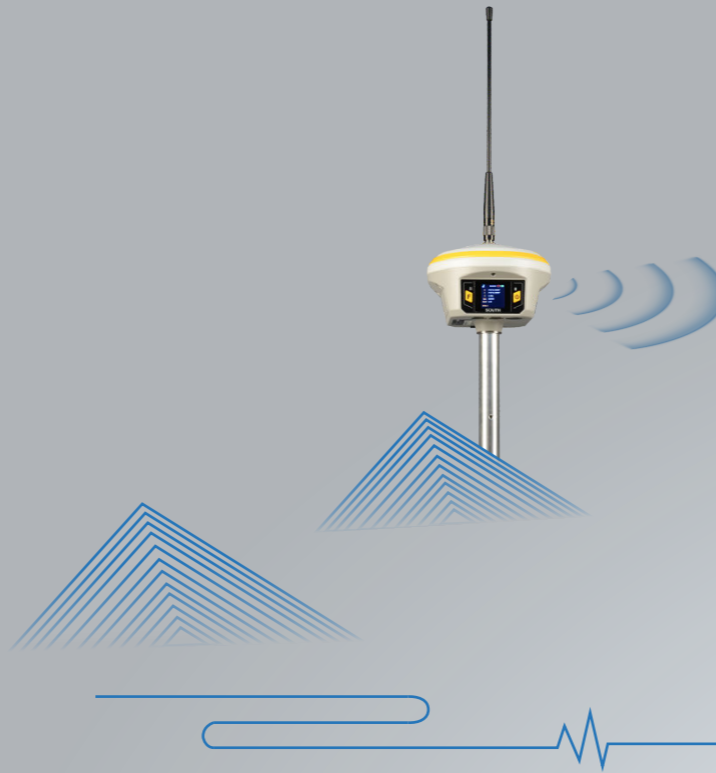
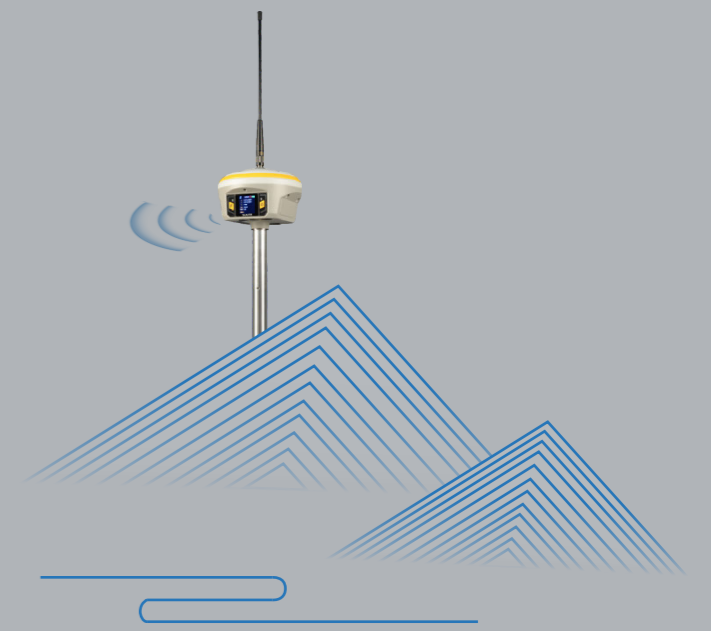

15 KM

Just use the inbuilt radio only

It is not a dream to achieve 15km working distance by using the inbuilt radio.





Touch Screen Interaction >>>

HD 1.54 inch color LCD touch screen with high brightness and low power consumption is more suitable for field work, which is convenient and efficient to complete touch settings, information browsing, function settings.



Slink & RTK XTRa >>>

Based on the RTX global services, INNO7 is able to achieve the goal of precise single-point positioning without a reference, the positioning is no more constrained by terrain environment, such as mountain, wasteland, desert, island, fixed solution is generally available as long as the GNSS constellations are visible.

Moreover, RTK XTRa technology which is derived from RTX services, it can extend RTK positioning for several minutes while the RTK primary source of correction stream is interrupted or not available, it really makes RTK bright anywhere.

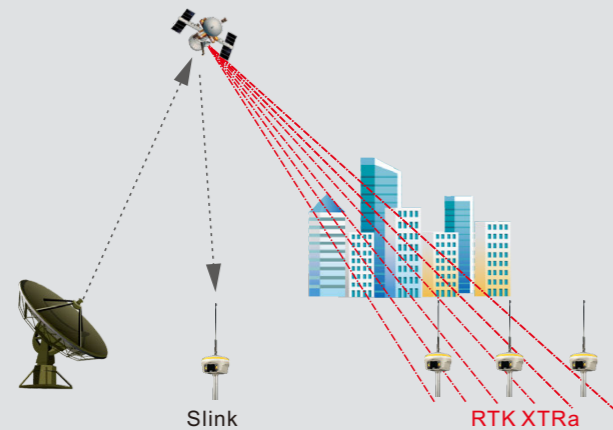

The 'Fast' IMU >>>

INNO7 is integrated with a new generation IMU module that it only needs 2-5s of shaking receiver to complete the initialization, and the maximum tilt compensation angle can be 60 degree. It can ignore magnetic interference while RTK receiver works in such a magnetic environment. This professional IMU module can keep the tilt effect for about 40s if RTK receiver stays on a point without moving.

IMU is an electronic unit which records angular velocity and linear acceleration data which is fed into a central processing unit for data interpreting and logging. When the RTK receiver moves, and then it will record the data and send back to the receiver for calculating to output the corrected result of position.

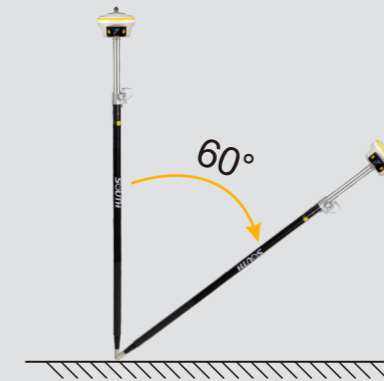

64GB SSD >>>

Built-in 64GB solid-state storage, which can meet most needs of measurement works. And the feature of cyclic storage helps receiver to automatically remove the previous files while there is not enough space in the memory, with this excellent performance, data storage can last almost 4 years based on 5s sampling interval. And the design of embedded memory chip can ensure the safety of measurement data.



RTK² >>>

Innovative "dual RTK engine algorithm technology" to achieve secondary coordinate check and calculation, effectively avoiding the problem of fake coordinates, more reliable coordinate accuracy and higher stability.



SurvStar APP >>>

Field Data Collection & Mapping: The Most Advanced is Here

Measure & Draw : Save Time in Field work and Office

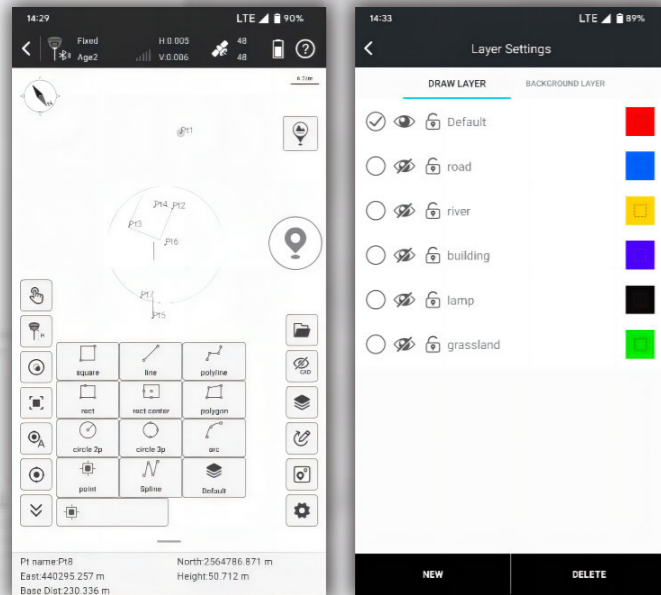

This feature allows you to draw the result map while completing point measurements.

- Before measuring points, users can choose the shape of the target object to be measured from 11 preset figures. The software will guide you to measure points in an order and automatically connect lines and complete the drawing of the figure.
- The .dxf or .dwg maps created on-site can be used directly in office work.
- Users can assign measured objects with different attributes, to different layers for measurement and management, making no mistakes.

Visual Positioning : Industry-Leading Non-Contact Measurement Technology

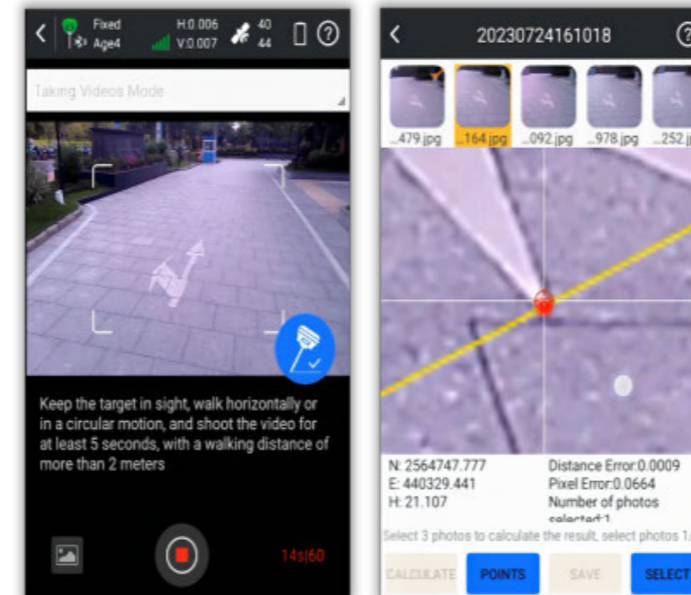

Photogrammetry Measurements can be conducted by taking pictures or videos. Coordinates of all points in the photos can be acquired.

- Now, target points that are inaccessible due to dangerous environments, poor satellite signals, or impassable terrain can be measured remotely.
- The captured image data can also be used with software like SGO, Pixel4D, DJI Terra, and CC for 3D modeling.
- Image measurement data can also be combined with drone measurement data to address issues of blurriness and deformation in ground data models collected by drones.

(This function only works with the receiver models that have front-facing camera or dual-cameras)

CAD Draw : Drafting without a PC

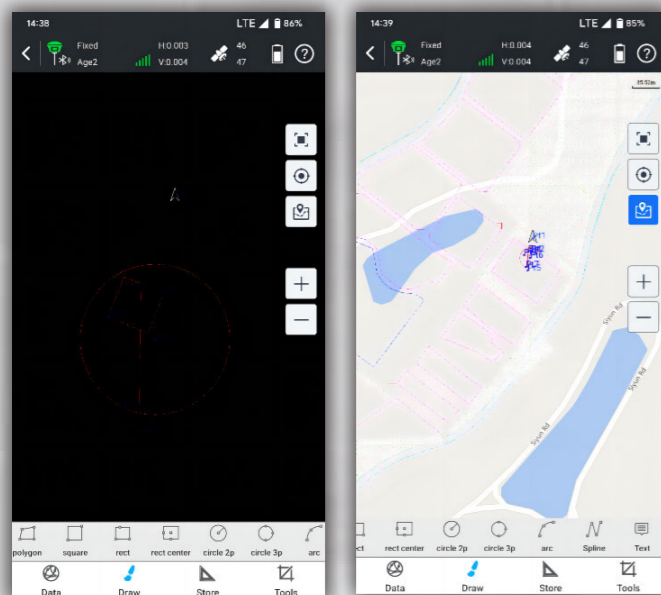

Select points to form a polygon, and directly identify the area division points for the surveyor to stake out. There is no more need for the user to guess a position to measure, and then to adjust.

- CAD drawing does not require a computer.
- CAD files prepared on office PCs can be edited and managed by users on RTK data collection terminals.
- Drawing tools include up to 11 types of figures and one type of text.

Static & PPK Measurement : More Assistance Now is Available

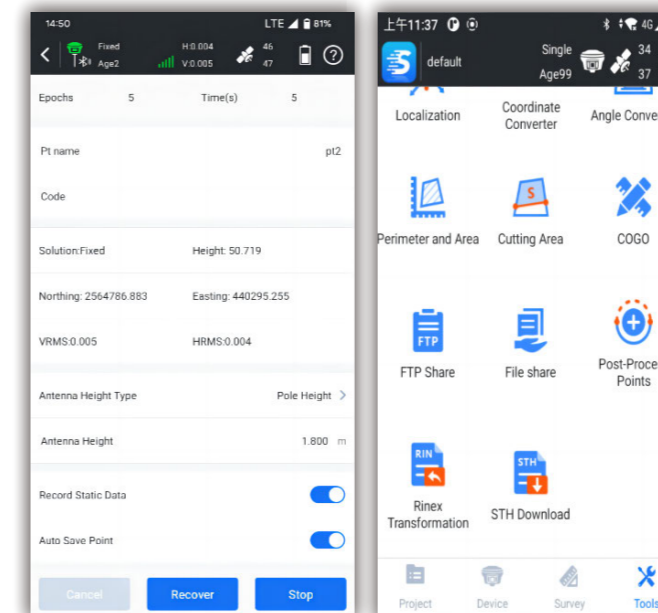

The software provides both static and PPK data collection capabilities.

- Data can be downloaded wirelessly, no need for a PC and cables.
- It is possible to convert .sth files into RINEX files right on the data collector or tablet or your phone, no need of PC.
- Data can be shared with others through mobile Internet.
- The accuracy of PPK data collection is as high as Trimble equipment, the result can be directly imported for use in TBC.

SurvStar APP >>>

Stakeout: Lighten Your Load, Increase Your Output

CAD Stake-Out : Save Labor Cost and Reduce Errors

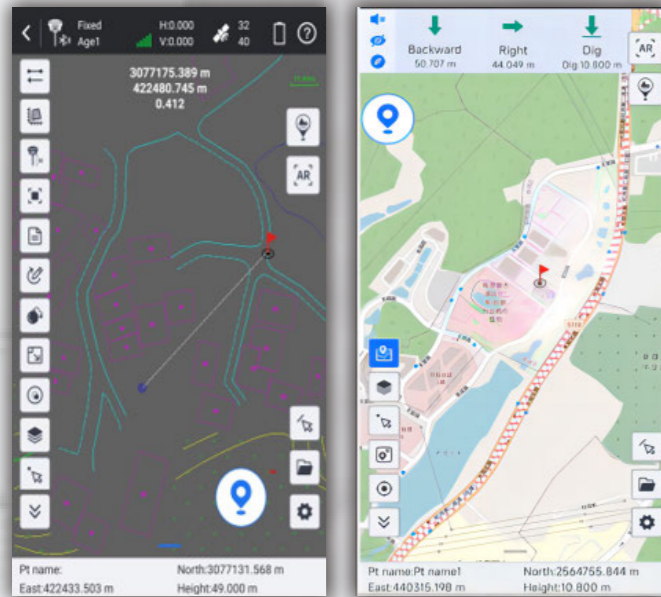

Traditional data collection software requires users to import points or lines to be setout from .csv or .txt files, users need to spend quite a lot of time to edit point and line libraries.

Moreover, for complex shapes such as curves, circles, and polygons, the traditional stake-out process is complicated. Now, our new CAD stake-out program offers a superior solution for surveyors.

- No need for manual editing of point libraries.
- Staking-out geometric shape is faster and easier.
- No need for obtaining coordinate files before work. Staking-out can be done with just a CAD drawing.
- Online maps and CAD drawings can be displayed simultaneously, improving accuracy.
- AR guide lines make staking-out more intuitive.

Live-View Stake-Out : Faster, More Accurate, More Intelligent

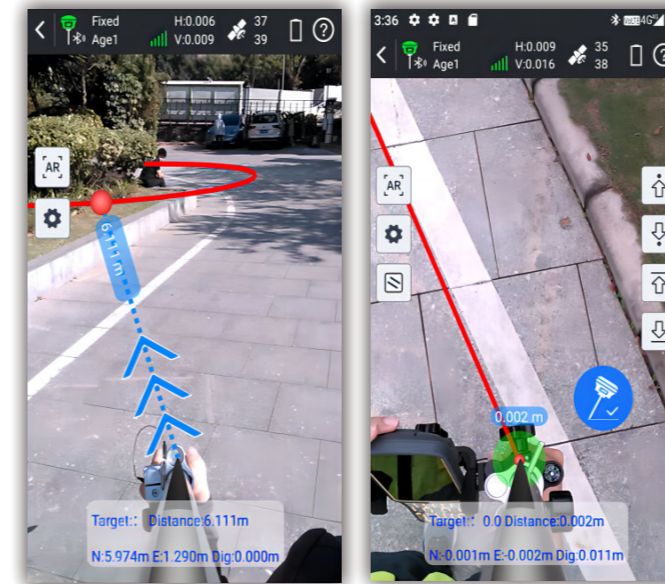

Users utilize the real-time imagery captured by the camera at the bottom of the receiver and the AR guide lines displayed by the software, to locate the target points.

- When users perform stake-out with a dual-camera GNSS receiver, the software can call upon both cameras to work together. At medium to long distances, the software uses the front-facing camera to indicate the direction of travel, and at close range, it uses the downward-facing camera to find the specific location. This further increases the speed of staking out.
- AR guide lines can be displayed in point staking out, line staking out, and CAD staking out programs.

(This function only works with the receiver models that have downward-facing camera or dual-cameras)

Additional Features

Area Division : Developed for Professional Cadastral Survey and Stake Out

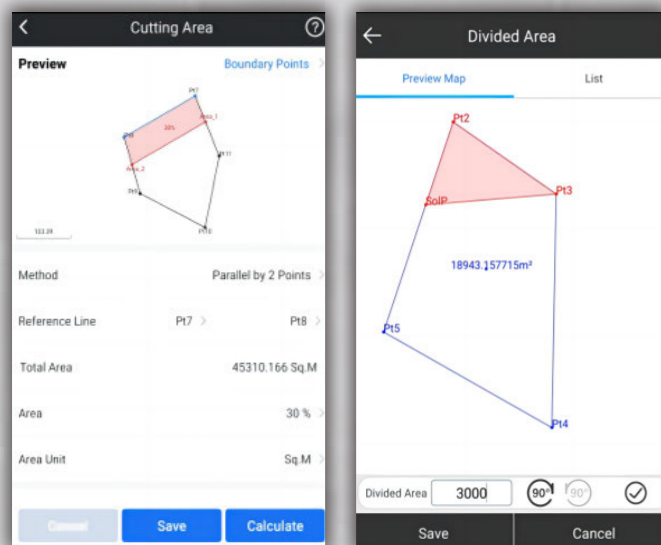

Select points to form a polygon, and directly identify the area division points for the surveyor to stake out. There is no more need for the user to guess a position to measure, and then to adjust.

- Six methods of division to determine the area division points. The methods are flexible and suitable to different user needs.
- The graphic display is intuitive and understandable.

Compatible with Multiple Devices

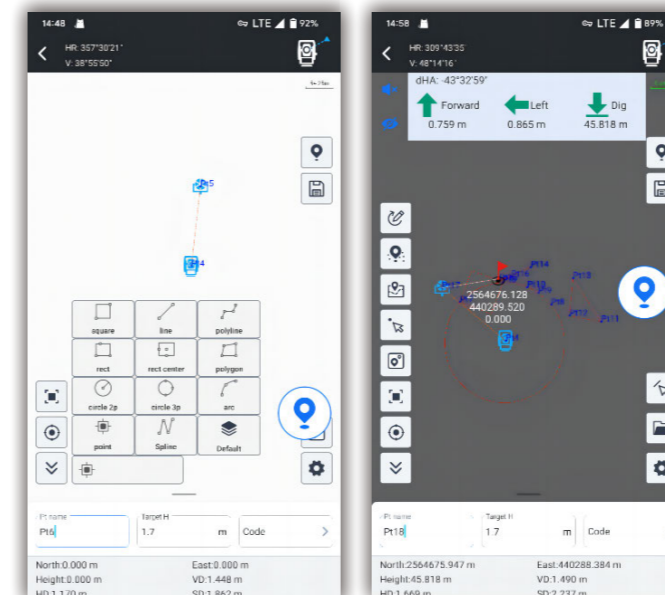

Innovations for Better User Experience

- RTK Data Backup
- QR Code Share
- Multiple Basemap Support
- Basemap
- Adjustment
- Network Mount Point Sorting
- NMEA Output Setting

The App Now works with GNSS, Total Station, Echo Sounder, GIS Tablet, in future it will work with SLAM Scanner, Terrestrial Lidar Scanner.

SOUTH Geo Office (SGO) >>>

Ideal GNSS Data Processor, Help You To Keep Advancing

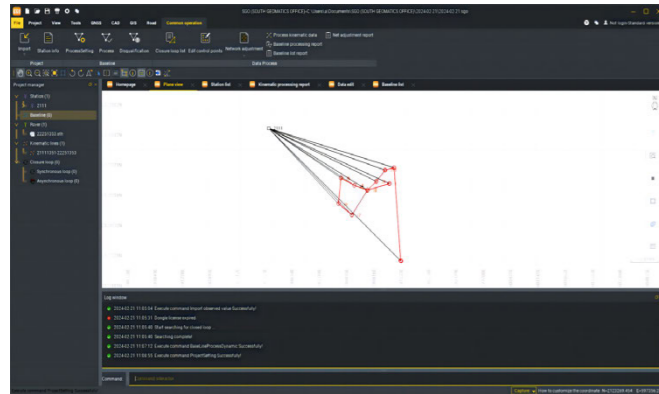
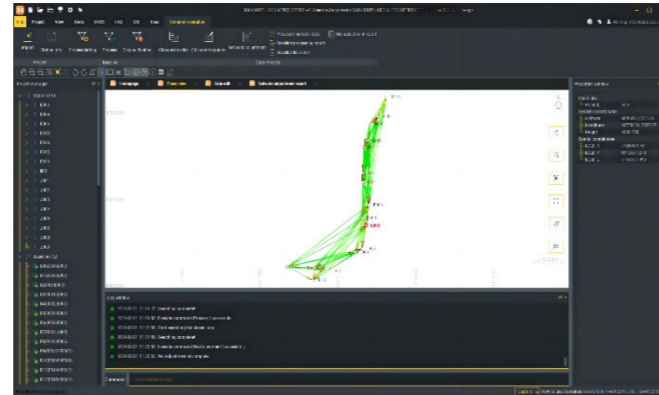
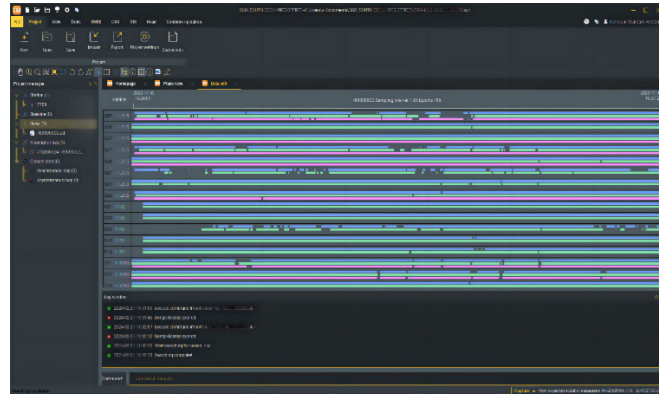

Data Processing & Reporting

When surveyors need to do post-processing of GNSS data, our software always can provide state-of-the-art technology to help you to produce optimal results. User just need to import field data, the software will automatically process GNSS baselines. Once results come out, the software can generate reports.

High Accuracy Guaranteed

RTK check, the unique function in our software, can compare RTK and PPK results to automatically acquire the most accurate coordinates for each target point.

It fills up the gap of poor corrections in RTK or hindered observations in PPK.

This improvement is to provide guarantee for your every survey.

RINEX Import and Export

This feature enables users to import the third party GNSS receiver data into our software and post-process it, by using the industry standard RINEX format.

3D Modelling

User can import photogrammetry image data into the software, to achieve 3D modeling, visually presenting geographic information data such as coordinates, areas, and volumes.

Model data can be transformed into different formats and applied with various coordinate parameters based on actual needs, making it adaptable to a wider range of application scenarios.

